

Kubota



KUBOTA COMPACT TRACK LOADER

SVL

SVL75

The outstanding power and exceptional comfort of Kubota's new Compact Track Loader takes high performance and productivity to a new level.



*This information is sourced from overseas and may not necessarily apply locally. It is essential that you confirm specifications and other information with your local Kubota dealer.

Need more productivity? Put the all-new Kubota Compact Track Loader to work for you.

Kubota, a trusted and world-leading manufacturer of construction equipment, is proud to introduce the all-new SVL75 Compact Track Loader. This new compact track loader delivers best-in-class bucket breakout force and lifting capacity, outstanding stability, a wide and comfortable operator area, and much more. When it comes to high performance, reliability and comfort, the road leads to Kubota.

- **OUTSTANDING PERFORMANCE**
- **EXCEPTIONAL COMFORT**
- **EASY MAINTENANCE AND IMPRESSIVE DURABILITY**

SVL75

Engine gross horsepower : 74.3 HP (55.4 kW)
Lifting capacity : 2214 kg
Rated operating load (35% of tipping load) : 1043 kg
Bucket breakout force : 2814 kg
Operating weight (Including operator weight 80 kg) : 4100 kg



COMPACT TRACK LOADER

SVL75



KUBOTA

SVL
75





OUTSTANDING PERFORMANCE

Kubota Engine

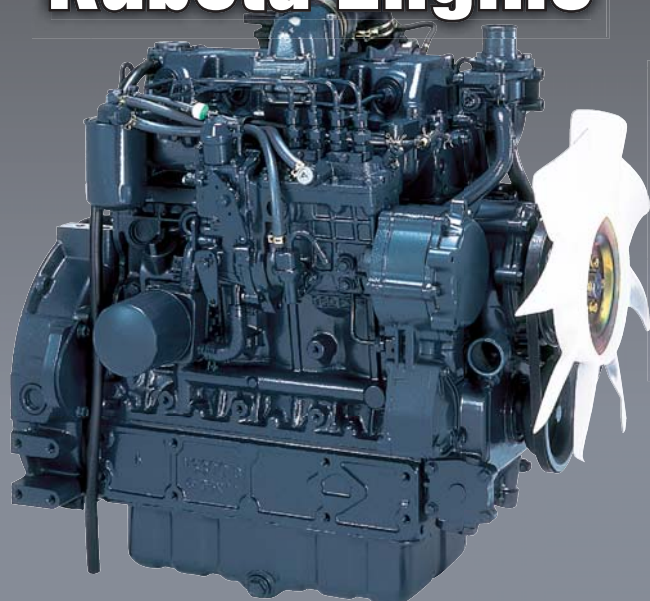

- **Best-in-class Engine Horsepower**

Kubota's high-powered engine provides 74.3 HP for performance that surpasses the competition.

- **Engine Stall Guard**

Prevent unexpected stalls and keep going even under tough working conditions.

With Engine Stall Guard - No Stalling

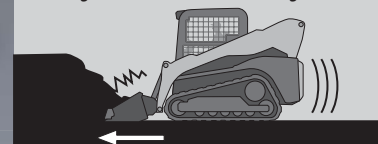

Without Engine Stall Guard - Engine Stalls

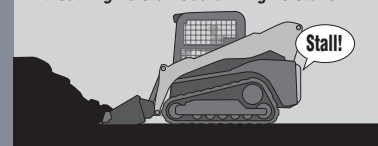



Bucket Breakout Force: 2814 kg
Arm Breakout Force: 2162 kg
Lifting Capacity: 2214 kg
Max Tipping Load: 2980 kg

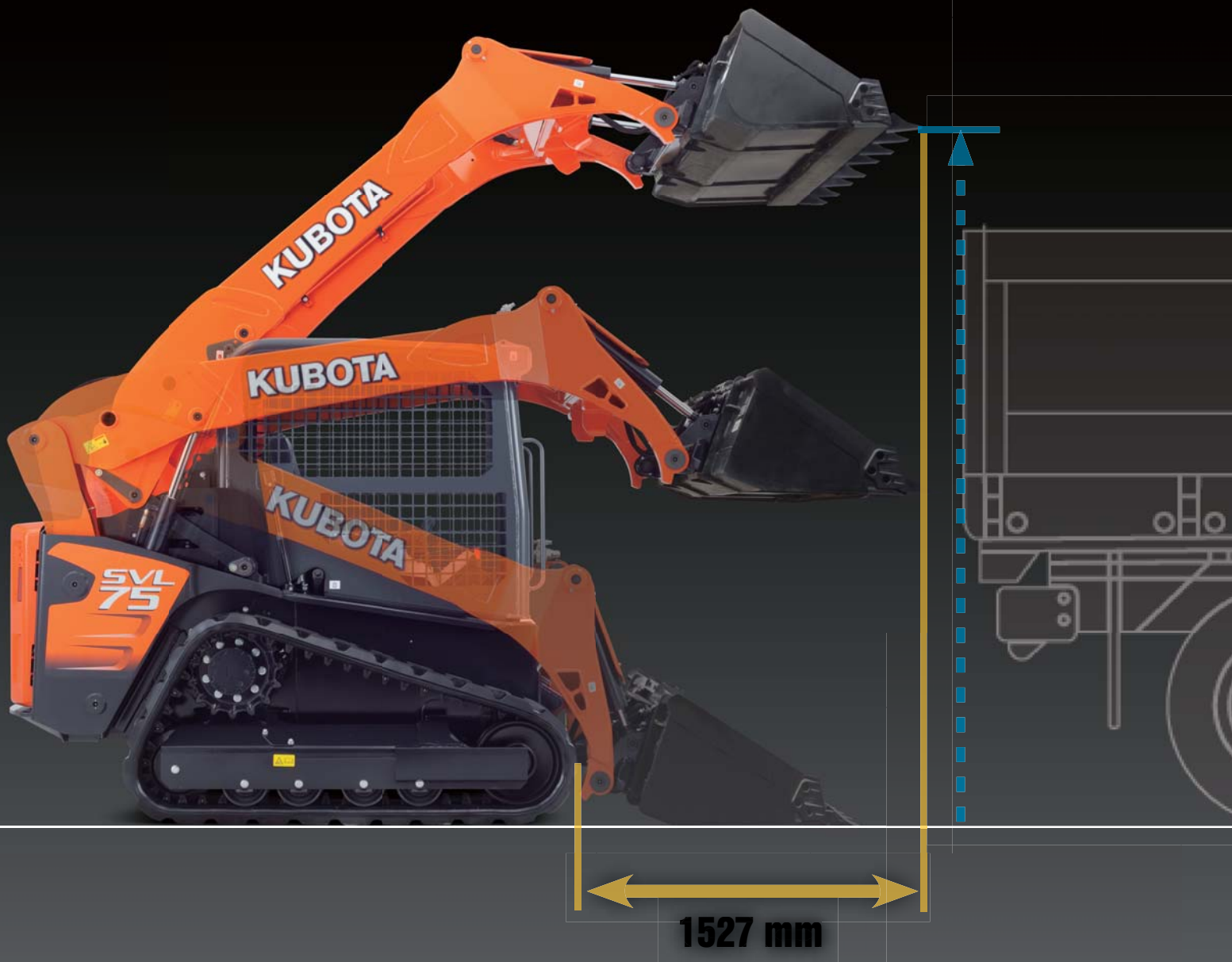

Kubota Unique Vertical Lift Design



- Long Reach For Maximum Lifting And Dumping
- High Bucket Hinge Pin Height

Kubota's unique vertical lift is designed to deliver an exceptionally long reach of 1060 mm. In addition, the tip of the arm is optimally shaped for a tall hinge pin height of 3025 mm for easy dumping into trucks.



- Standard Self-levelling Function

This feature helps keep the bucket or fork in a horizontal position without the need to manually adjust the angle during lifting.



Travel Performance

1. Standard Two-speed Travel

Shift from low gear at 7.5 km/h to high gear at 11.5 km/h to get the job done faster.

2. Pilot Valve With Shuttle Piston

This ensures consistent oil flow which improves stability when going straight.

3. Higher Ground Clearance

A high ground clearance of 296 mm lets you travel over large obstacles with ease.

4. Strong Traction Force

Kubota's original track lug design gives you more grip and stronger traction force.



EXCEPTIONAL COMFORT

Comfortable Cab

● Wider Cab Entrance

A wider entrance makes it easier to get in and out.

● Wide And Clean Cab

The spacious interior minimises fatigue even during long work hours.

● High-back Full Suspension Seat

The standard suspension seat offers outstanding comfort.

● Arm Rest

The spacious cab also includes ergonomically placed arm rests on the right and left sides of the seat to minimise operator fatigue.

● Wide Leg Room

The cab provides ample leg room to reduce operator fatigue.

● Easy-clean Floor Mat and Drain Outlet

The soft rubber floor mat is easy to remove and clean. And with the built-in drain outlet, the mat can be washed in the cab.

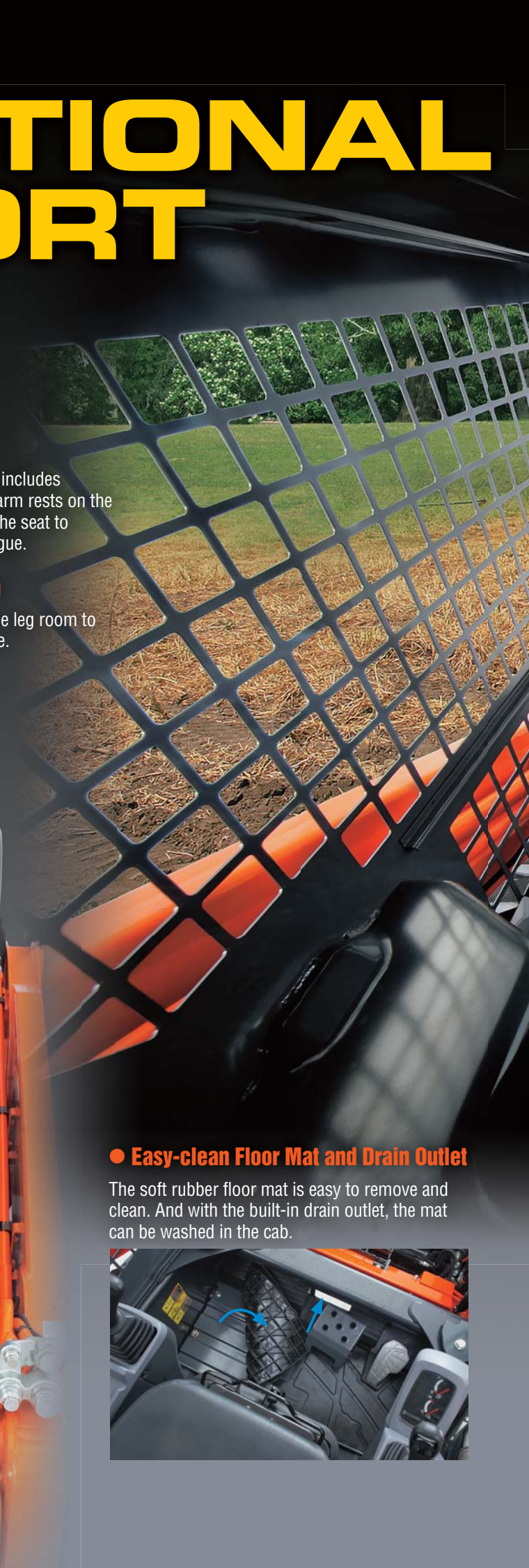

Excellent 360° Visibility

The edge of the bucket can be seen from the seat. Improved visibility translates to better safety on the job.



● Hand and Foot Throttle

The hand and foot throttle allows you to match the engine speed to the task. The hand throttle is ideal for jobs requiring constant engine speed such as cold planing, trenching or snow blowing. The foot throttle lets the operator vary engine speed for other applications.



EXCEPTIONAL COMFORT

Pressurised Cab

The cab is pressurised to keep dust, flying debris, and insects away to enhance comfort on the job. Furthermore, noise is kept down to let you work for long hours with minimal fatigue.



Excellent Air Conditioning Performance

● Optimised Air Conditioning

The climate control system offers outstanding cooling and heating performance with optimised airflow for a high level of comfort all year round.

● Enhanced Defrosting and Demisting Functions

Ample airflow prevents the windows from fogging up or freezing during the cold months of the year.



CAB

Easy-open Sliding Front Windows

The sliding front and double-sliding side windows can be opened regardless of the position of the front attachment, allowing you to get in or out safely even during emergencies.



EASY MAINTENANCE IMPRESSIONS DU

Easy Maintenance



The SVL75 offers easy access to the hydraulic pump, valves, lines and hydraulic tank.

● Routine Checks

Simply open the rear bonnet to access all components for daily routine inspections.

● Slide-and-tilt Radiator and Oil Cooler

The radiator can be tilted for easy cleaning.



● Large Space for Tool Box

The SVL75 offers a convenient and large tool box for storing a grease gun and other necessities.



PERFORMANCE & DURABILITY

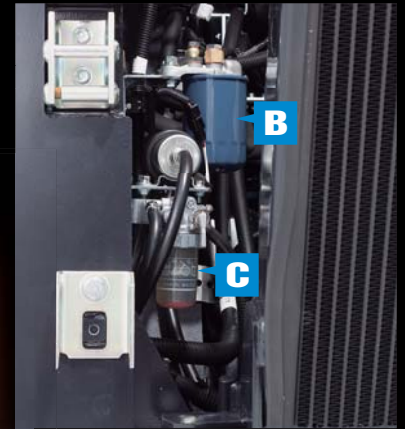
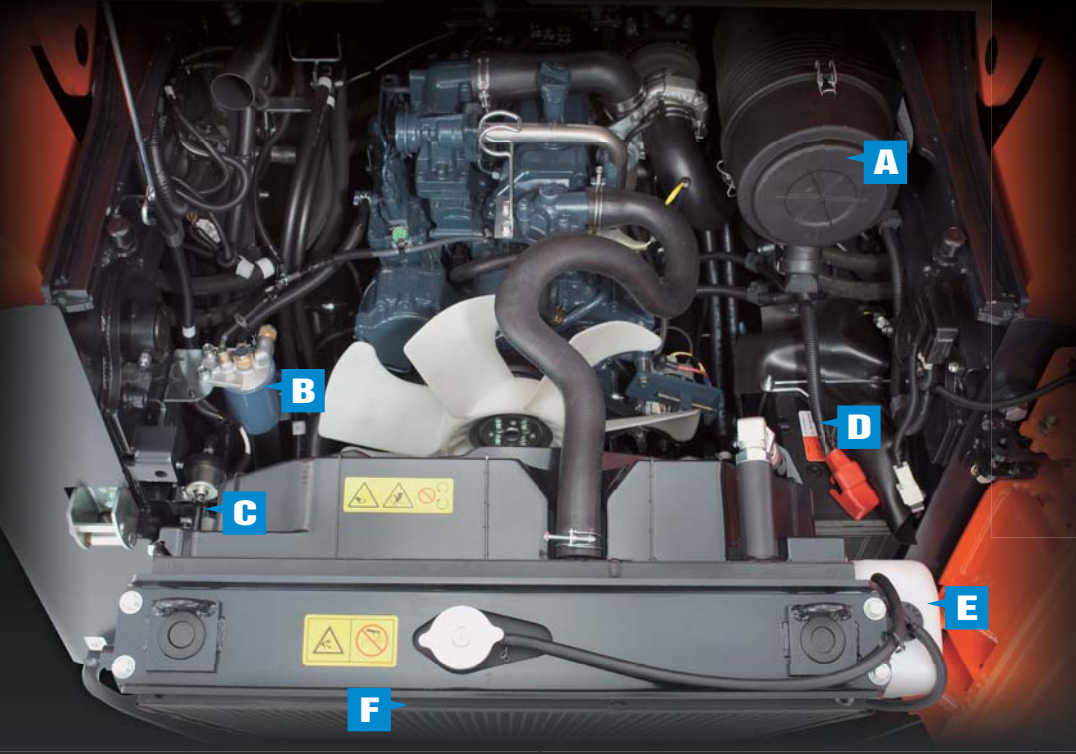

A. Dual Element Air Cleaner
D. Maintenance-Free Battery

B. Fuel Filter
E. Coolant

C. Water Separator
F. Slide And Tilt Radiator

Impressive Durability

1. Welded, Integrated Mainframe and Undercarriage

The undercarriage forms an integral part of the main frame for maximum durability.

2. Kubota Original Rubber Tracks

Kubota's original rubber tracks offer outstanding durability and long-life performance. Furthermore, Kubota's original lug pattern prevents soil from accumulating and improves traction force.

3. Triple Flange Lower Track Rollers

A highly reliable triple flange design not only minimises the risk of detracking, but improves stability as well.

4. Belly Pan

Prevents damage to the rear door.

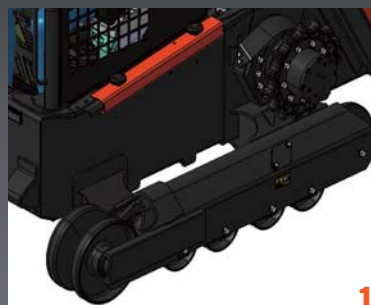

VERSATILITY

With a wide variety of attachments available*, Kubota Compact Track Loaders are the most versatile machine on your jobsite.

**Not all attachments are OEM-KUBOTA.*

4-in-1 Bucket



Auger



Grapple Bucket



Pallet Fork



Sweeper



Brush Cutter

Tiller

Buckets

Tilt Attach

Broom

Breaker

Dozer Blade

Standard Hydraulic Quick Coupler

You can attach or remove attachments using a switch without leaving the seat.



EQUIPMENT

STANDARD EQUIPMENT

- Open CAB (ROPS / FOPS Level 1)
- Top / Rear window
- Suspension seat
- 2" Retractable seat belt
- Operator presence control
- Pull down arm rest
- Hand / Foot throttle
- 12V electric outlet
- Horn
- Lockable fuel cap
- Backup alarm
- Working lights (Front 2 / Rear 2)
- Glow plug
- Mechanical quick coupler
- Loader arm float function
- Bucket self-leveling (up only)
- Wet disc parking brakes
- Two-speed travel
- Rubber crawler
- Hydraulic quick coupler

SPECIFICATIONS

Model			SVL75
Type of operator station			Open CAB / Closed CAB
Engine	Model		V3307-DI-TE3
	Gross HP	HP (kW)/rpm	74.3 (55.4)/2400
	Displacement		cc
	Cylinders		4
	Bore × Stroke		mm
	Aspiration		Turbocharged
Loader Performance	Rated operating capacity-35% tipping load		kg
	Rated operating capacity-50% tipping load		kg
	Tipping load		kg
	Breakout force	Bucket	kg
		Lift arm	kg
	Lifting capacity		kg
	Lift arm path		Vertical
Undercarriage	Track Width	Standard	mm
		Wide	mm
	Ground pressure with standard track		psi
	Ground pressure with wide track		psi
	Track rollers (per side)		4
	Track ground contact length		mm
	Travel speed	Low	km/h
		High	km/h
	Traction force		kg
Min. ground clearance		mm	
Hydraulic system	Loader hydraulic flow		ℓ/min.
	Loader hydraulic pressure		kgf/cm ²
	Aux. hydraulic flow	Standard	ℓ/min.
		High	ℓ/min.
Service refill capacities	Hydraulic system		ℓ
	Hydraulic tank		ℓ
	Fuel tank		ℓ
Operating weight (Includes operator weight 80 kg)			kg

The company reserves the right to change the above specifications without notice. This brochure is for descriptive purposes only. Please contact your local Kubota dealer for warranty information. For your safety, Kubota strongly recommends the use of a Rollover Protective Structure (ROPS) and seat belt in almost all applications.

DIMENSIONS

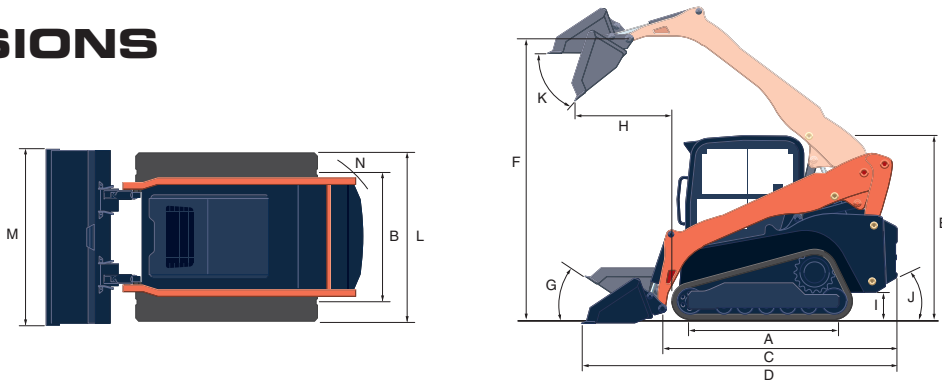

Model			SVL75
A	Length of track on ground	mm	1436
B	Track gauge	mm	1355
C	Length w/o bucket	mm	2768
D	Length w/bucket on ground	mm	3576
E	Height to top of cab	mm	2083
F	Bucket hinge pin height at max. lift	mm	3025
G	Rollback angle at carry position	degree	27
H	Reach at max. lift and dump	mm	1060
I	Ground clearance	mm	296
J	Departure angle	degree	31.5
K	Max. dump angle	degree	40
L	Vehicle width	mm	1675
M	Width with bucket	mm	1727
N	Turning radius from centre-machine rear	mm	2720



©2012 Kubota Corporation

Kubota

KUBOTA Tractor Australia Pty Ltd

25-29 Permas Way, TRUGANINA Vic, 3029
Freecall: 1800 334 653
Email: sales@kubota.com.au

Web Site: <http://www.kubota.com.au>

CB Norwood Distributors Ltd

PO Box 1265, 888 Tremain Avenue,
Palmerston North 0800 KUBOTA
Tel: 06 356 4920 Fax: 06 356 4939

Web Site: <http://www.kubota.co.nz>